

射频同轴转接器/ RF Coaxial Adapter

XQY-N-3.5-JKGD

项目 Project	指标 Indicators
产品名称 Product Name	射频转接器/RF Adaptor
频率范围 Frequency Range	DC-18GHz
驻波比 VSWR	1.15:1 (max)
阻抗 Impedance	50 Ω
插入损耗 Insertion Loss	0.30dB (max)
介质耐电压 Dielectric withstand voltage	1000 V
使用寿命 Service life	≥500
绝缘电阻 Insulation Resistance	≥5000MΩ
A 接头类型 A connector type	N-Male
B 接头类型 B connector type	3.5mm-Female
工作温度 Operation Temperature	-55°C ~ +165°C
内导体材质 Inner conductor material	铍青铜 镀金 White Bronze Gold Plating
外导体材质 External conductor material	不锈钢 钝化 Stainless Steel Passivated
绝缘体 Insulator	PTFE

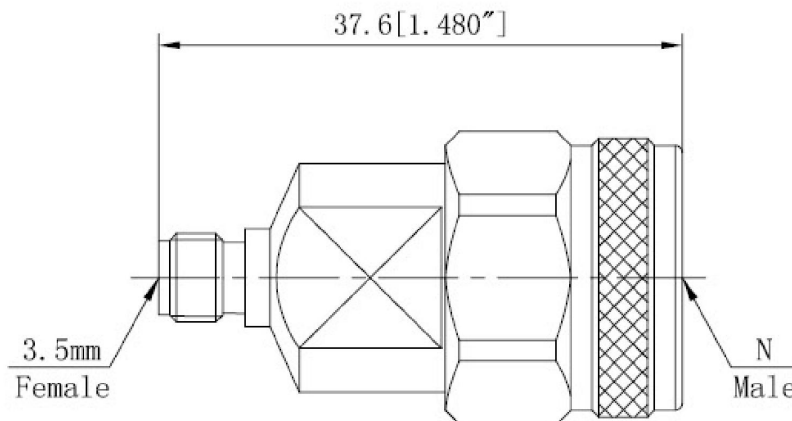

注: 尺寸(mm/[英寸]) , 一般公差(± 0.05)

Note: Dimensions (mm / [inch]), General tolerance (±0.05)